

THE PROPERTY OF THE DRAWING IS ESTABLISHED BY LAW. IT IS FORBIDDEN TO PRODUCE OR SHOW IT TO THIRD PART. WITHOUT A WRITTEN AGREEMENT.

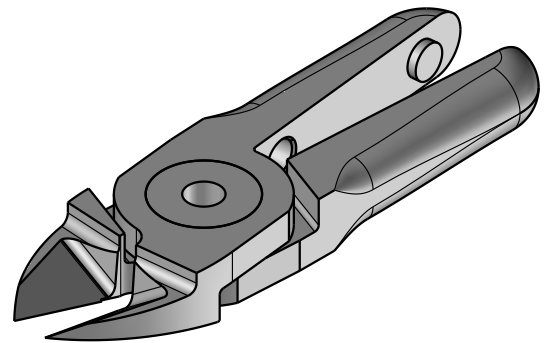
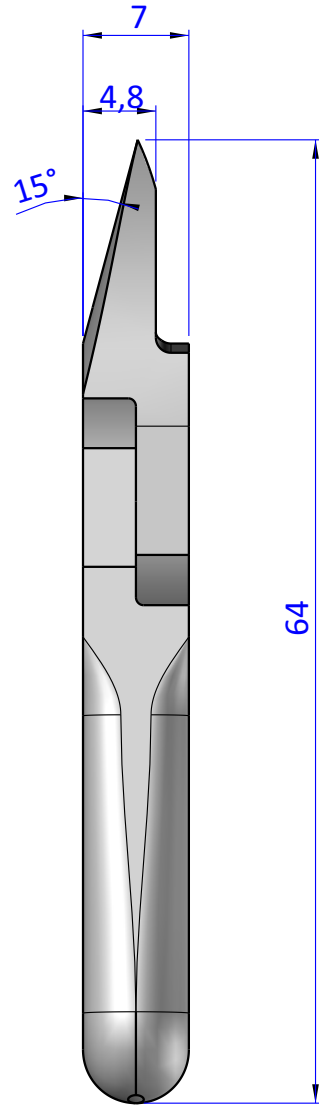
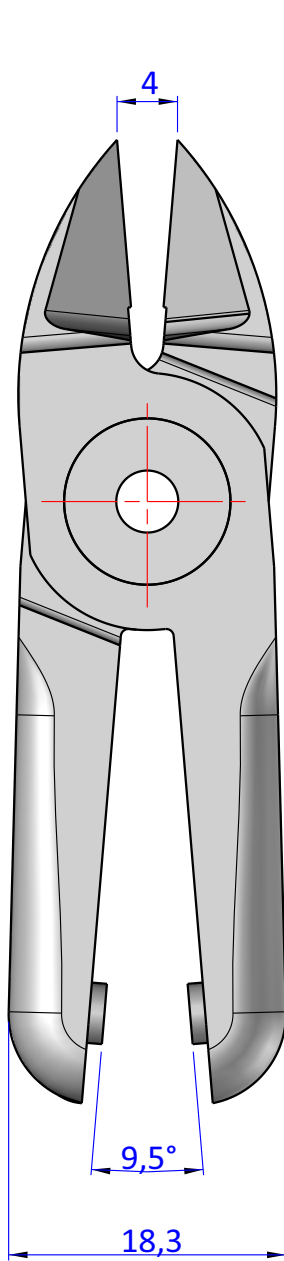

DESIGNED FROM FPS Automation		REVIEW A
DATE 22/10/2020	WEIGHT 0,040kg	
CODE VES.N5AP		

Format **A4**

UNI 936-76

GENERAL TOLERANCE

UNI - ISO 2768

CLASSE **f**

DESCRIPTION

VES.N5AP